

lightbout.iQ

Rinia Range

5w/m

Linear LED Tape

Wattage:	5w/m			
LED Lumen p/m:	200lm/m	230lm/m	260lm/m	260lm/m
Efficacy:	40lm/w	46lm/w	52lm/w	52lm/w
Colour Temperature:	2000K	2400K	2700K	3000K
Colour Rendering Index:	93+			
Voltage:	24vDC			
IP Rating:	IP20			

Lifetime:	50,000 Hours
Operating Temperature:	-20°C to 40°C

Width:	8mm (+0.25)
Maximum Reel Length:	5 Meters
Cut Increments:	100mm (+0.25)
Wiring:	Parallel
Dimming:	1-10v / Mains / DALI*

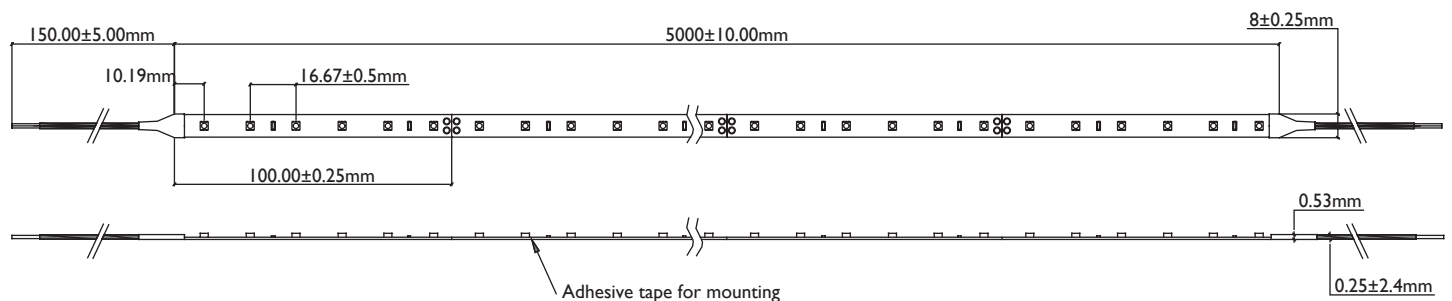

+90 CRI

	Wattage	CCT	IP Rating	Length	Profile
RINIA LED TAPE:	5 w/m	K	IP20	mm	Yes/No

Rinia LED tapes provide an extensive range suitable for residential and commercial applications. Binned to two to three Macadam steps, the Rinia tape provides an industry leading quality of light. Supplied in reels to be cut and soldered on site or made to order within custom profiles with end caps and pre-wired tails.

5w/m

Linear LED Tape

CIE Chromaticity Diagrams:

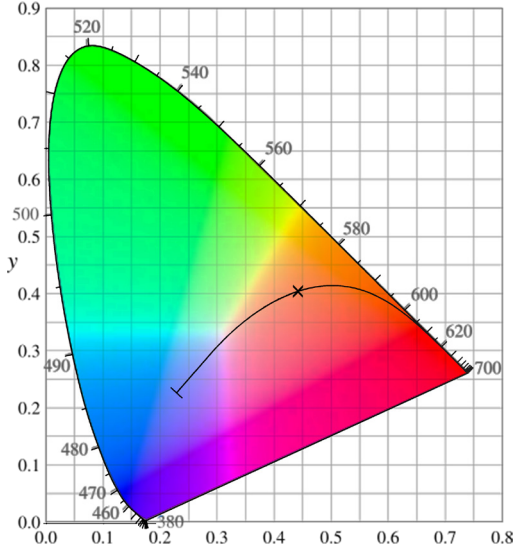

Colour Rendering Index:

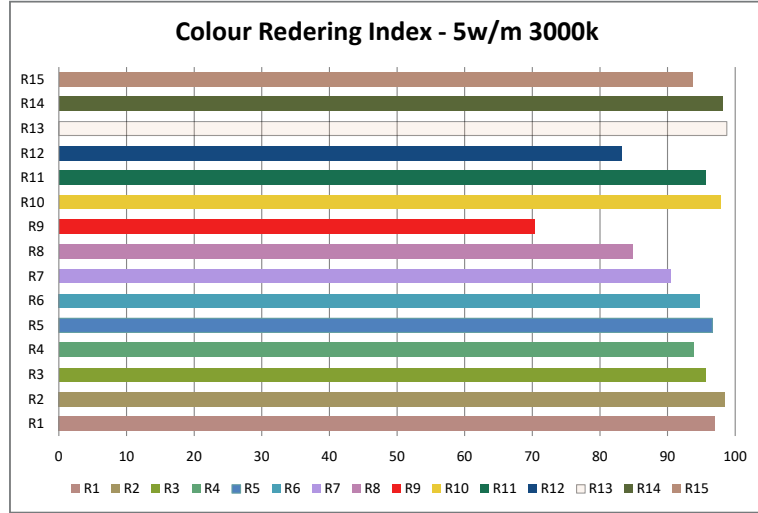

R1	97
R2	98.4
R3	95.6
R4	93.8
R5	96.6
R6	94.8
R7	90.4
R8	84.7
R9	70.3
R10	97.8
R11	95.6
R12	83.2
R13	98.7
R14	98
R15	93

Data Source: 5w/m 3000k Rinia LED Tape

Environment: 2.9lux 4372K

Power Supplies & Control Interfaces

Power Supplies	Wattage	Voltage	Length	Height	Width
PS2024	20w	24vDC	118 _{mm}	35 _{mm}	26 _{mm}
PS6024	60w	24vDC	163 _{mm}	42.5 _{mm}	32 _{mm}
PS10024	100w	24vDC	190 _{mm}	52 _{mm}	37 _{mm}
PS15024	150w	24vDC	228 _{mm}	68 _{mm}	39 _{mm}

Dimming Interface	Control	Wattage	Length	Height	Width
PS10024PD	Mains Dimmable	100w	230 _{mm}	70 _{mm}	46 _{mm}
DINT	1-10v Dimmable	120w	172 _{mm}	42 _{mm}	20 _{mm}

Please use the recommended power supplies and dimming interfaces to ensure a smooth dimming curve.

Indicative 1-10v Wiring Diagram

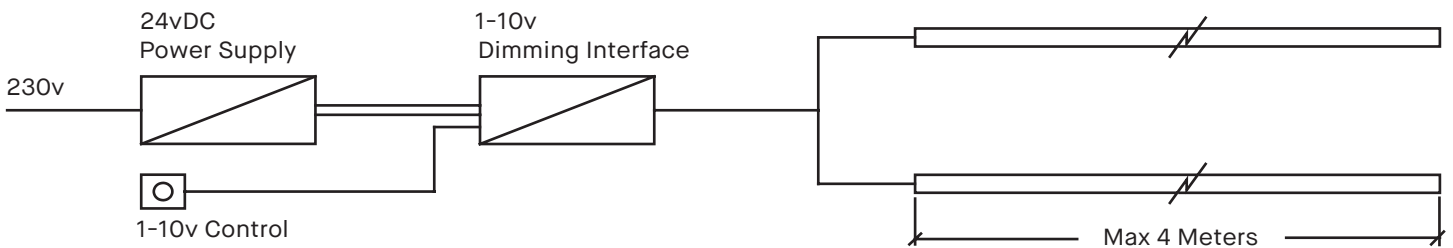

REQUIRED	OPTIONAL	Power Supply: W
<p>LED Tape + Heat-sink + Power Supply</p>	<p>Profile + Dimming Interface</p>	<p>Control: 1-10v / MD</p>

PLEASE NOTE:

Power supplies & dimmable interfaces must be placed in accessible, safe and well ventilated locations. If the LED tape is to be placed over 1 Meter away from the power supply please ensure voltage drop does not exceed 3%. Electrician to ensure correct cabling is specified. Please contact lightbout.iQ for more information.

5w/m IP65

Linear LED Tape

Wattage: 5w/m
 LED Lumen p/m: 455lm/m
 Efficacy: 91lm/w
Colour Temperature: 2700K
 Colour Rendering Index: 95CRI
 Voltage: 24vDC
 IP Rating: IP20

Lifetime: 50,000 Hours
 Operating Temperature: -20°C to 40°C

Width: 10mm (+0.25)
 Maximum Reel Length: 5 Meters
 Cut Increments: 33mm (+0.25)
 Wiring: Parallel
 Dimming: 1-10v / Mains / DALI*

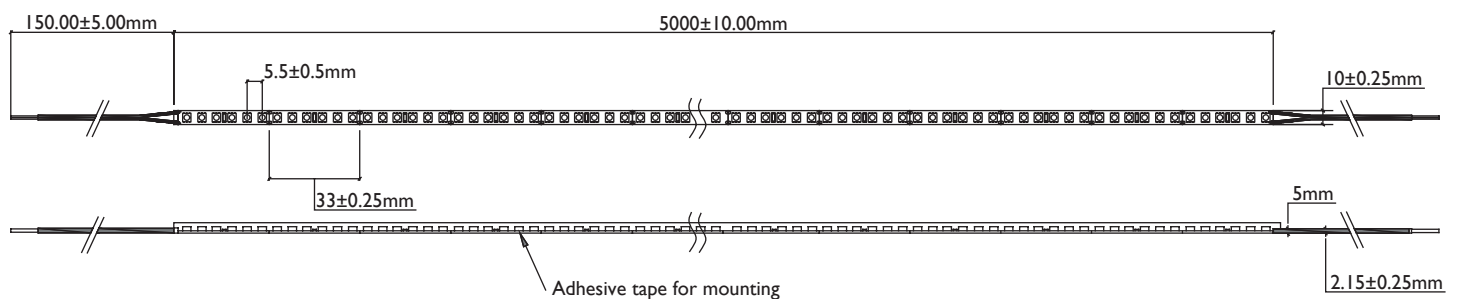

	Wattage	CCT	IP Rating	Length	Profile
RINIA LED TAPE:	20 w/m	K	IP65	mm	Yes/No

Rinia LED tapes provide an extensive range suitable for residential and commercial applications. Binned to two to three Macadam steps, the Rinia tape provides an industry leading quality of light. Supplied in reels to be cut and soldered on site or made to order within custom profiles with end caps and pre-wired tails.

5w/m IP65

Linear LED Tape

CIE Chromaticity Diagrams:

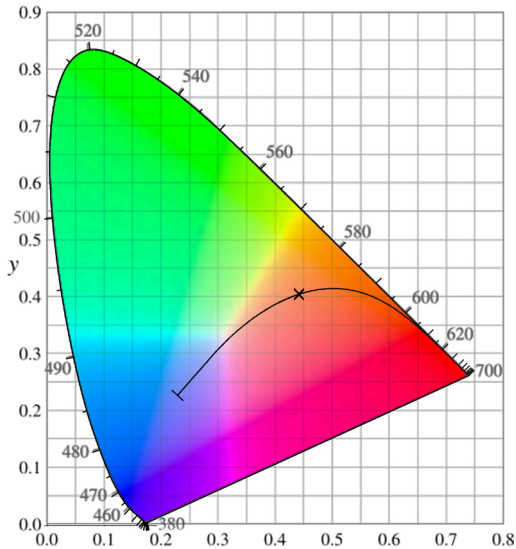

Colour Rendering Index:

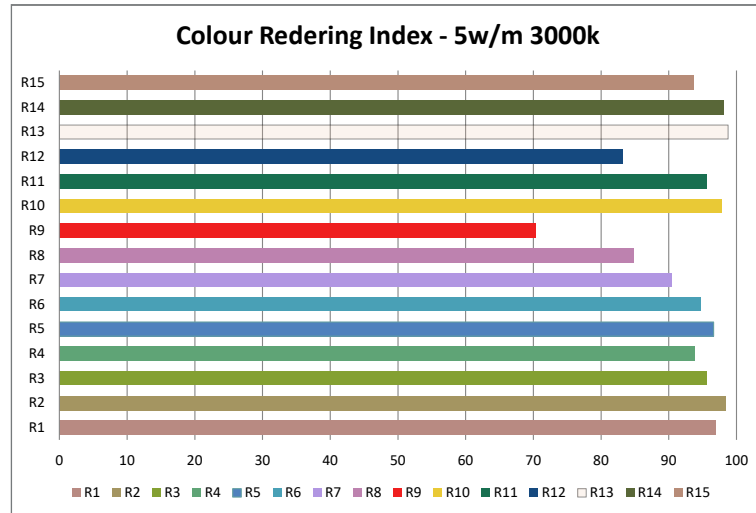

R1	97
R2	98.4
R3	95.6
R4	93.8
R5	96.6
R6	94.8
R7	90.4
R8	84.7
R9	70.3
R10	97.8
R11	95.6
R12	83.2
R13	98.7
R14	98
R15	93

Data Source: PRIOR TO ENCAPSULATION 5w/m 3000k Rinia LED Tape

Environment: 2.9lux 4372K

Power Supplies & Control Interfaces

Power Supplies	Wattage	Voltage	Length	Height	Width
PS2024	20w	24vDC	118 _{mm}	35 _{mm}	26 _{mm}
PS6024	60w	24vDC	163 _{mm}	42.5 _{mm}	32 _{mm}
PS10024	100w	24vDC	190 _{mm}	52 _{mm}	37 _{mm}
PS15024	150w	24vDC	228 _{mm}	68 _{mm}	39 _{mm}

Dimming Interface	Control	Wattage	Length	Height	Width
PS10024PD	Mains Dimmable	100w	230 _{mm}	70 _{mm}	46 _{mm}
DINT	1-10v Dimmable	120w	172 _{mm}	42 _{mm}	20 _{mm}

Please use the recommended power supplies and dimming interfaces to ensure a smooth dimming curve.

Indicative 1-10v Wiring Diagram

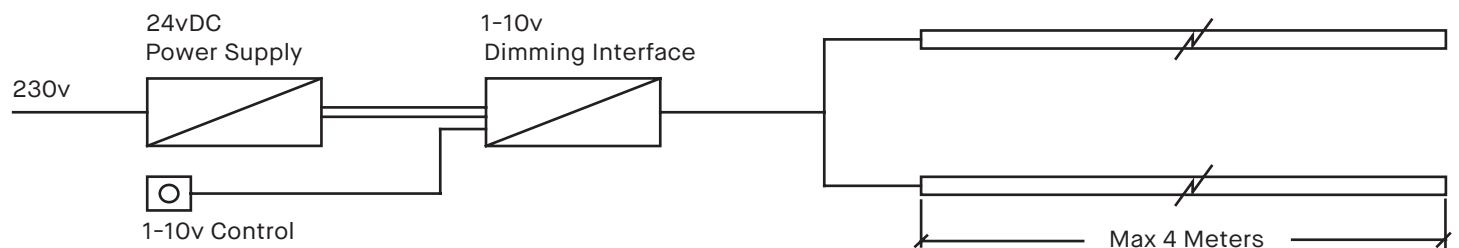

REQUIRED	OPTIONAL	
RINIA LED TAPE: + +	+	Power Supply: W Control: 1-10v / MD

PLEASE NOTE:

Power supplies & dimmable interfaces must be placed in accessible, safe and well ventilated locations. If the LED tape is to be placed over 1 Meter away from the power supply please ensure voltage drop does not exceed 3%. Electrician to ensure correct cabling is specified. Please contact lightbout.iQ for more information.

10w/m Linear LED Tape

Wattage:	10w/m			
LED Lumen p/m:	440lm/m	490lm/m	510lm/m	515lm/m
Efficacy:	44lm/w	49lm/w	51lm/w	51lm/w
Colour Temperature:	2000K	2400K	2700K	3000K
Colour Rendering Index:	+93CRI			
Voltage:	24vDC			
IP Rating:	IP20			

Lifetime:	50,000 Hours
Operating Temperature:	-20°C to 40°C

Width:	8mm (+0.25)
Maximum Reel Length:	5 Meters
Cut Increments:	50mm (+0.25)
Wiring:	Parallel
Dimming:	1-10v / Mains / DALI*

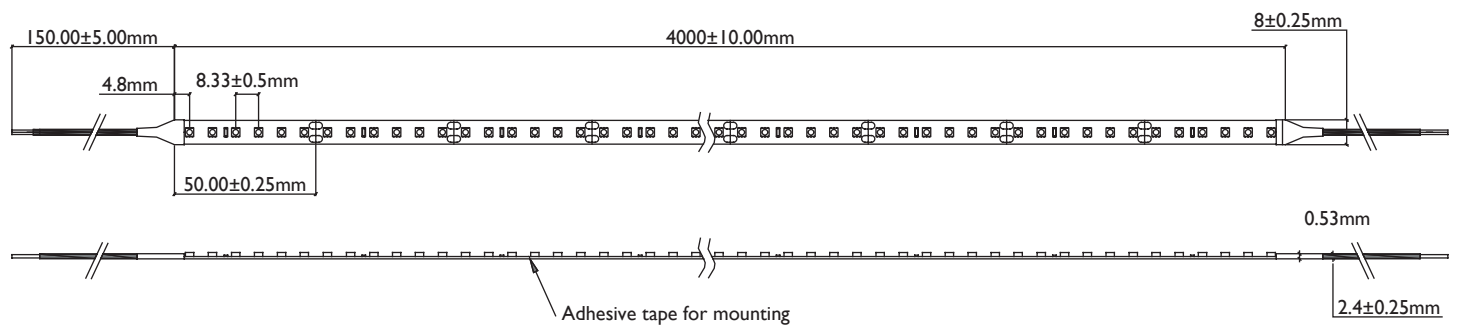

+90 CRI

	Wattage	CCT	IP Rating	Length	Profile
RINIA LED TAPE:	10 w/m	K	IP20	mm	Yes/No

Rinia LED tapes provide an extensive range suitable for residential and commercial applications. Binned to two to three Macadam steps, the Rinia tape provides an industry leading quality of light. Supplied in reels to be cut and soldered on site or made to order within custom profiles with end caps and pre-wired tails.

10w/m Linear LED Tape

CIE Chromaticity Diagrams:

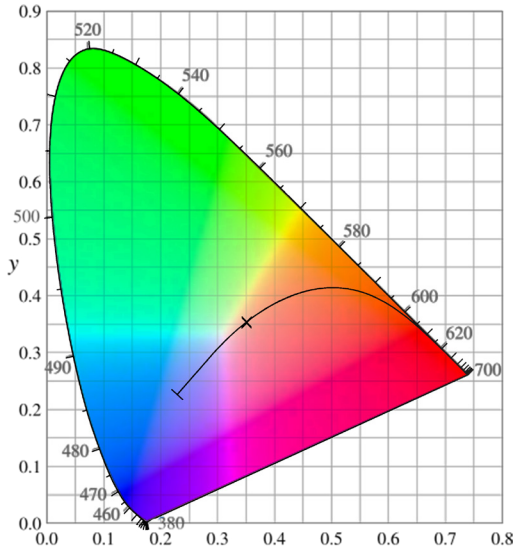

Colour Rendering Index:

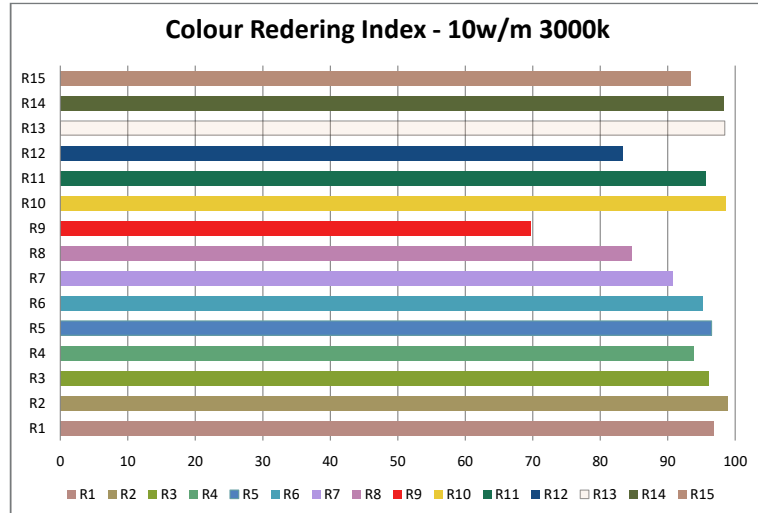

R1	96.7
R2	98.8
R3	96
R4	93.8
R5	96.4
R6	95.2
R7	90.6
R8	84.7
R9	69.7
R10	98.6
R11	95.6
R12	83.3
R13	98.4
R14	98.3
R15	93.3

Data Source: 10w/m 3000k Rinia LED Tape

Environment: 2.9lux 4372K

Power Supplies & Control Interfaces

Power Supplies	Wattage	Voltage	Length	Height	Width
PS2024	20w	24vDC	118mm	35mm	26mm
PS6024	60w	24vDC	163mm	42.5mm	32mm
PS10024	100w	24vDC	190mm	52mm	37mm
PS15024	150w	24vDC	228mm	68mm	39mm

Dimming Interface	Control	Wattage	Length	Height	Width
PS10024PD	Mains Dimmable	100w	230mm	70mm	46mm
DINT	1-10v Dimmable	120w	172mm	42mm	20mm

Please use the recommended power supplies and dimming interfaces to ensure a smooth dimming curve.

Indicative 1-10v Wiring Diagram

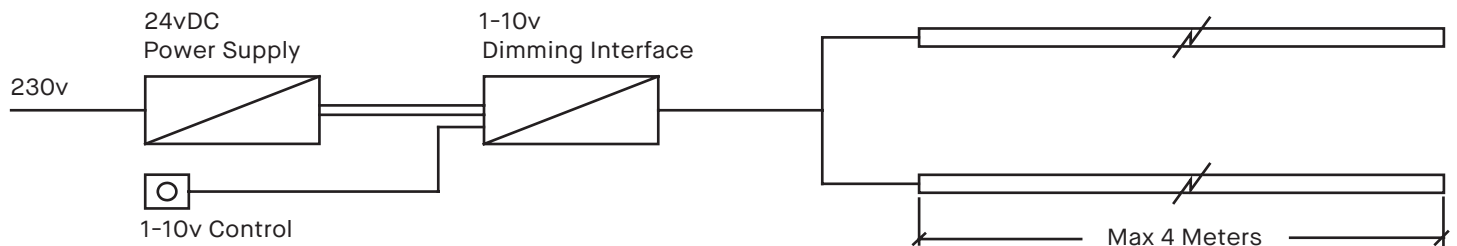

REQUIRED	OPTIONAL	Power Supply: W
+ +	+	
LED Tape	Profile	Control: 1-10v / MD

PLEASE NOTE:

Power supplies & dimmable interfaces must be placed in accessible, safe and well ventilated locations. If the LED tape is to be placed over 1 Meter away from the power supply please ensure voltage drop does not exceed 3%. Electrician to ensure correct cabling is specified. Please contact lightbout.iQ for more information.

10w/m Pro

Linear LED Tape

Wattage:	10w/m			
LED Lumen p/m:	>880lm/m	>885.3lm/m	>941.4lm/m	>976.7lm/m
Efficacy:	88lm/w	91.12lm/w	101.23lm/w	109.54lm/w
Colour Temperature:	2200K	2400K	2700K	3000K
Colour Rendering Index:	98CRI			
Voltage:	24vDC			
IP Rating:	IP20			

Lifetime:	50,000 Hours
Operating Temperature:	-20°C to 40°C

Width:	10mm (+0.25)
Maximum Reel Length:	5 Meters
Cut Increments:	45mm (+0.25)
Wiring:	Parallel
Dimming:	1-10v / Mains / DALI*

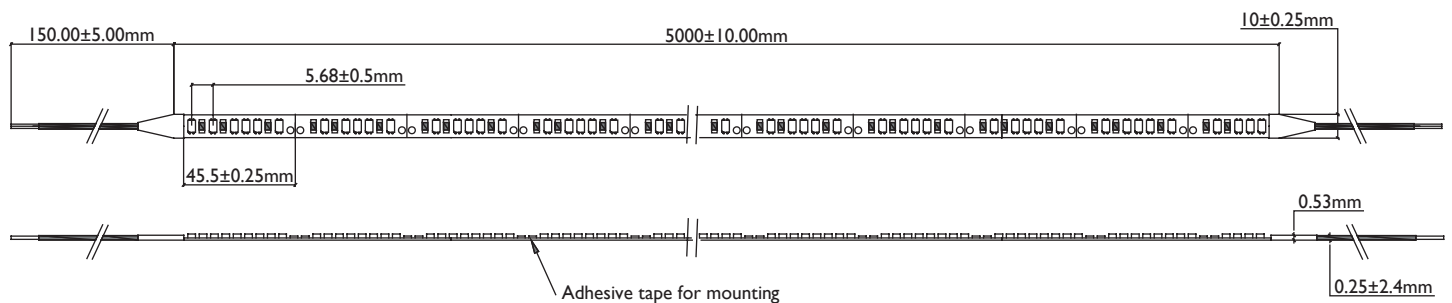

	Wattage	CCT	IP Rating	Length	Profile
RINIA LED TAPE:		K	IP20	mm	Yes/No

Rinia LED tapes provide an extensive range suitable for residential and commercial applications. Binned to two to three Macadam steps, the Rinia tape provides an industry leading quality of light. Supplied in reels to be cut and soldered on site or made to order within custom profiles with end caps and pre-wired tails.

10w/m Pro

Linear LED Tape

CIE Chromaticity Diagrams:

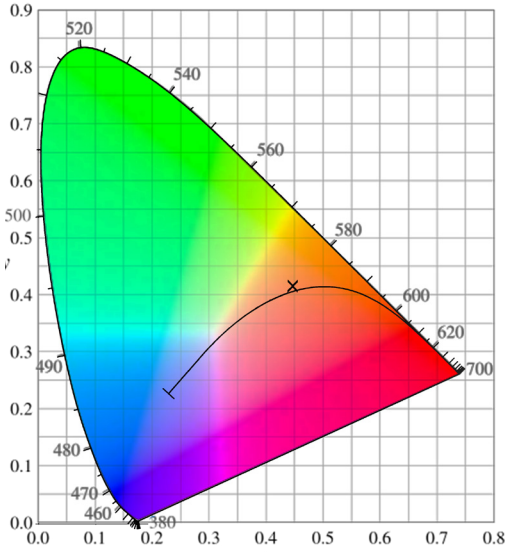

Data Source: 10w/m 2700k Rinia LED Tape
Environment: 1.8lux 4372K

Colour Rendering Index:

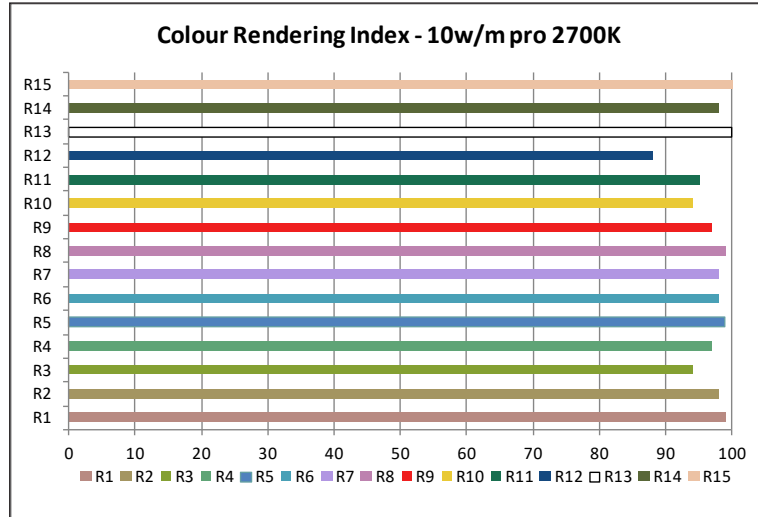

R1	99
R2	98
R3	94
R4	97
R5	99
R6	98
R7	98
R8	99
R9	97
R10	94
R11	95
R12	88
R13	100
R14	98
R15	100

Power Supplies & Control Interfaces

Power Supplies	Wattage	Voltage	Length	Height	Width
PS2024	20w	24vDC	118 _{mm}	35 _{mm}	26 _{mm}
PS6024	60w	24vDC	163 _{mm}	42.5 _{mm}	32 _{mm}
PS10024	100w	24vDC	190 _{mm}	52 _{mm}	37 _{mm}
PS15024	150w	24vDC	228 _{mm}	68 _{mm}	39 _{mm}

Dimming Interface	Control	Wattage	Length	Height	Width
PS10024PD	Mains Dimmable	100w	230 _{mm}	70 _{mm}	46 _{mm}
DINT	1-10v Dimmable	120w	172 _{mm}	42 _{mm}	20 _{mm}

Please use the recommended power supplies and dimming interfaces to ensure a smooth dimming curve.

Indicative 1-10v Wiring Diagram

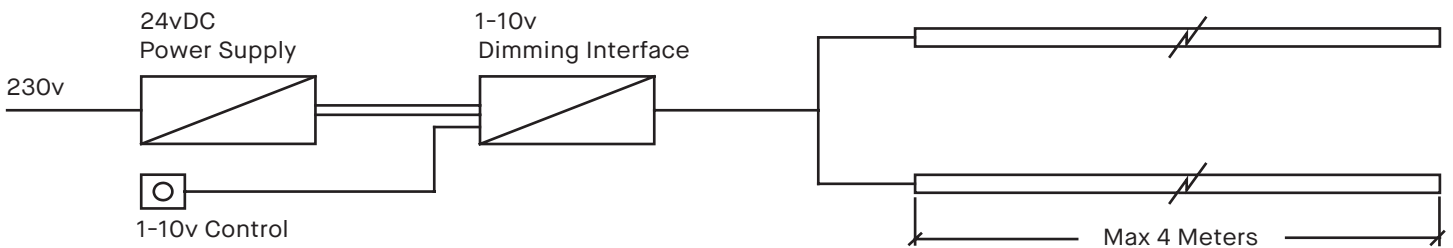

REQUIRED	OPTIONAL	Power Supply: W
<p>LED Tape + Heat-sink + Power Supply</p>	<p>Profile + Dimming Interface</p>	<p>Control: 1-10v / MD</p>

PLEASE NOTE:

Power supplies & dimmable interfaces must be placed in accessible, safe and well ventilated locations. If the LED tape is to be placed over 1 Meter away from the power supply please ensure voltage drop does not exceed 3%. Electrician to ensure correct cabling is specified. Please contact lightbout.iQ for more information.

10w/m IP54

Linear LED Tape

Wattage:	10w/m	
LED Lumen p/m:	575lm/m	650lm/m
Efficacy:	57.5lm/w	65lm/w
Colour Temperature:	2400K	2700K
Colour Rendering Index:	95CRI	
Voltage:	24vDC	
IP Rating:	IP54	

Lifetime:	50,000 Hours
Operating Temperature:	-20°C to 40°C

Width:	8mm (+0.25)
Maximum Reel Length:	5 Meters
Cut Increments:	50mm (+0.25)
Wiring:	Parallel
Dimming:	1-10v / Mains / DALI*

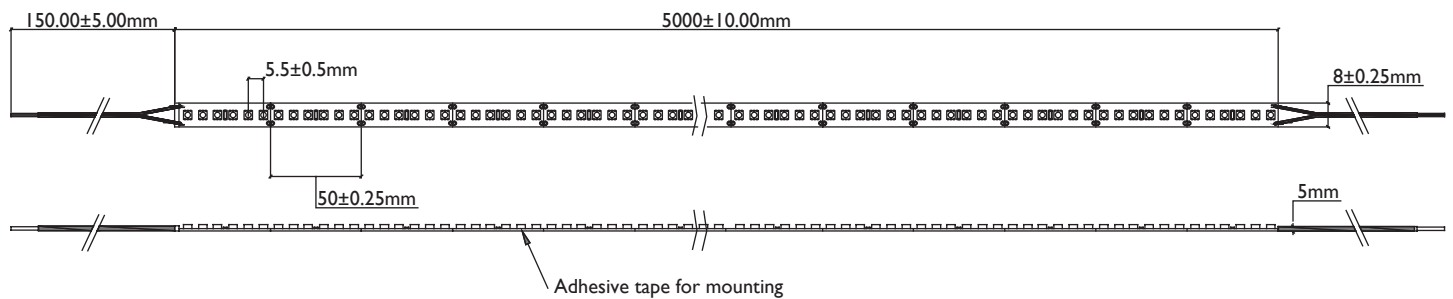

	Wattage	CCT	IP Rating	Length	Profile
RINIA LED TAPE:	10 w/m	K	IP65	mm	Yes/No

Rinia LED tapes provide an extensive range suitable for residential and commercial applications. Binned to two to three Macadam steps, the Rinia tape provides an industry leading quality of light. Supplied in reels to be cut and soldered on site or made to order within custom profiles with end caps and pre-wired tails.

10w/m IP54

Linear LED Tape

CIE Chromaticity Diagrams:

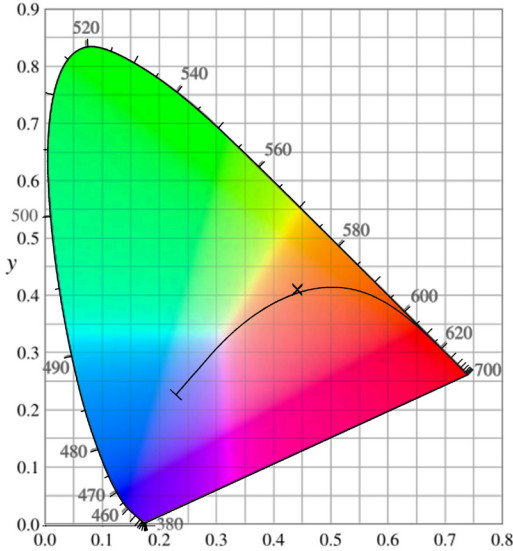

Data Source: 10w/m IP54 Rinia LED Tape

Environment: 2.9lux 4372K

Colour Rendering Index:

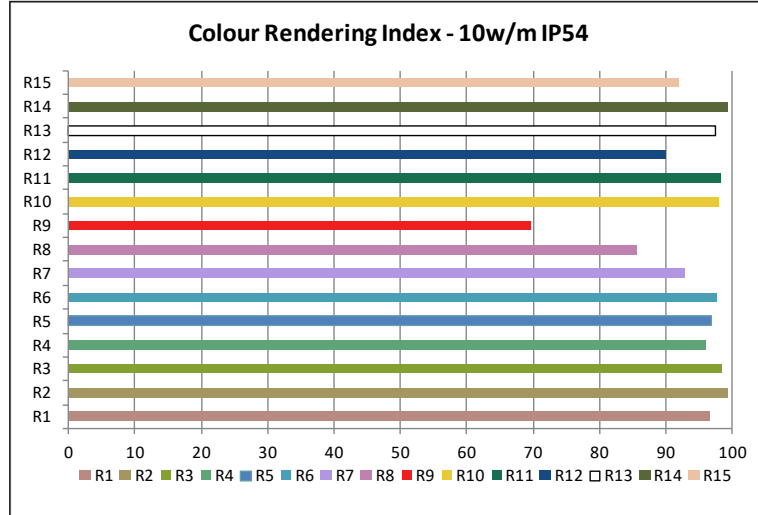

R1	96
R2	99
R3	98
R4	96
R5	97
R6	98
R7	93
R8	86
R9	70
R10	98
R11	98
R12	90
R13	97
R14	99
R15	92

Power Supplies & Control Interfaces

Power Supplies	Wattage	Voltage	Length	Height	Width
PS2024	20w	24vDC	118mm	35mm	26mm
PS6024	60w	24vDC	163mm	42.5mm	32mm
PS10024	100w	24vDC	190mm	52mm	37mm
PS15024	150w	24vDC	228mm	68mm	39mm

Dimming Interface	Control	Wattage	Length	Height	Width
PS10024PD	Mains Dimmable	100w	230mm	70mm	46mm
DINT	1-10v Dimmable	120w	172mm	42mm	20mm

Please use the recommended power supplies and dimming interfaces to ensure a smooth dimming curve.

Indicative 1-10v Wiring Diagram

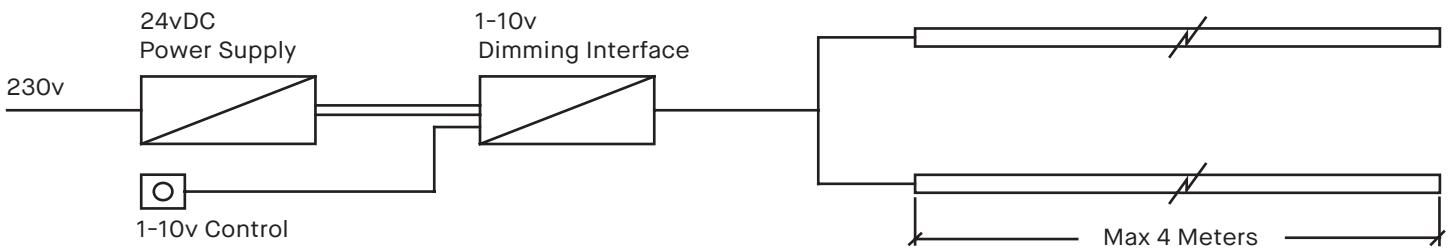

RINIA LED TAPE:	REQUIRED	OPTIONAL	Power Supply: W
	+ +	+	Control: 1-10v / MD

PLEASE NOTE:

Power supplies & dimmable interfaces must be placed in accessible, safe and well ventilated locations. If the LED tape is to be placed over 1 Meter away from the power supply please ensure voltage drop does not exceed 3%. Electrician to ensure correct cabling is specified. Please contact lightbout.iQ for more information.

10.5w/m Top Flex

Linear LED Tape

Wattage:	10.5w/m	Wiring:	Parallel
LED Lumen p/m:	320lm/m	Dimming:	1-10v, Mains or DALI*
Efficacy:	30.5lm/w		
Colour Temperature:	2400K / 2700K		
Colour Rendering Index:	>80	Accessories:	End Caps
Voltage:	24vDc		Front Connector
IP Rating:	IP67		Mount Clip
			50mm Channel
Lifetime:	50,000 Hours		
Operating Temperature:	-20°C to 40°C		
Width:	16mm (±0.2)		
Height:	16mm (±0.2)		
Maximum Reel Length:	10 Meters		
Cut Increments:	55mm		

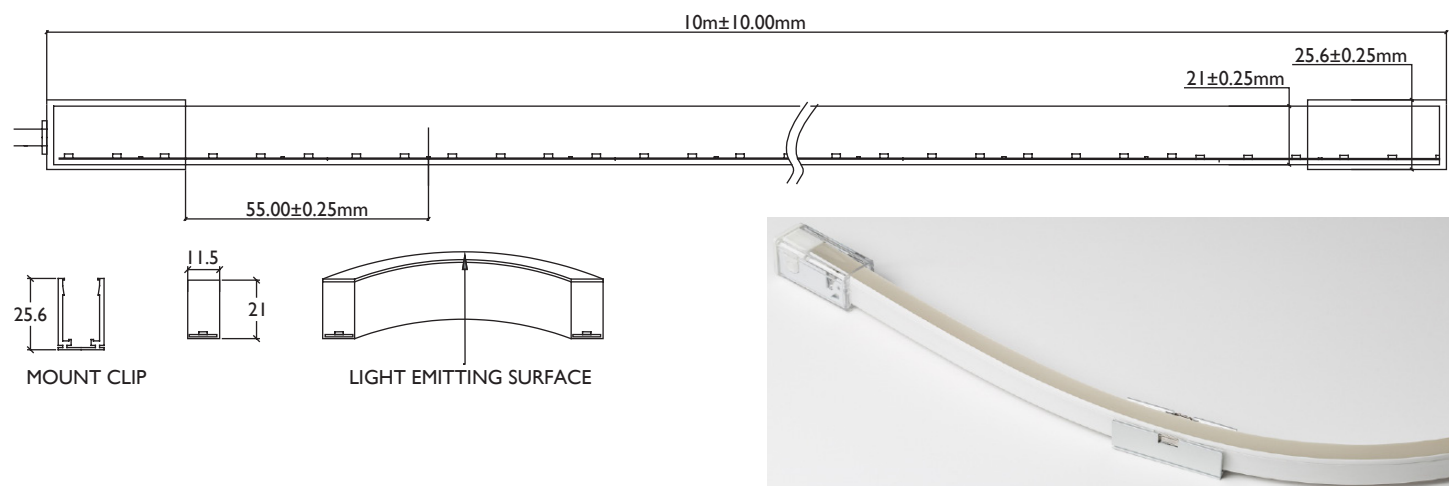

	Wattage	CCT	IP Rating	Length	Profile
RINIA LED TAPE:	TOP		IP67	mm	Yes/No

Rinia LED tapes provide an extensive range suitable for residential and commercial applications. Binned to two to three Macadam steps, the Rinia tape provides an industry leading quality of light. Supplied in reels to be cut and soldered on site or made to order within custom profiles with end caps and pre-wired tails.

10.5w/m Top Flex Linear LED Tape

CIE Chromaticity Diagrams:

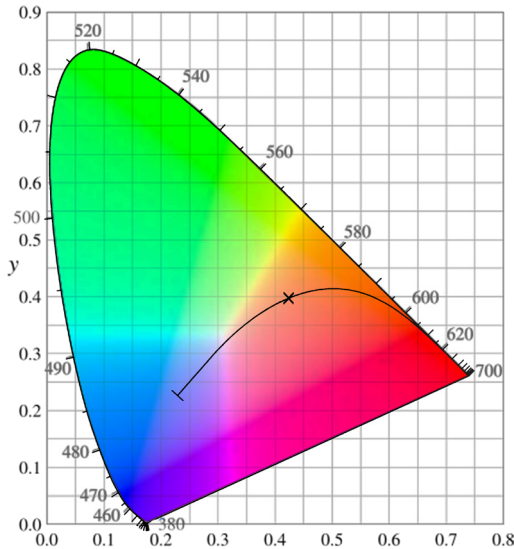

Data Source: Rinia LED Top Flex

Environment: 2.9lux 4372K

Colour Rendering Index:

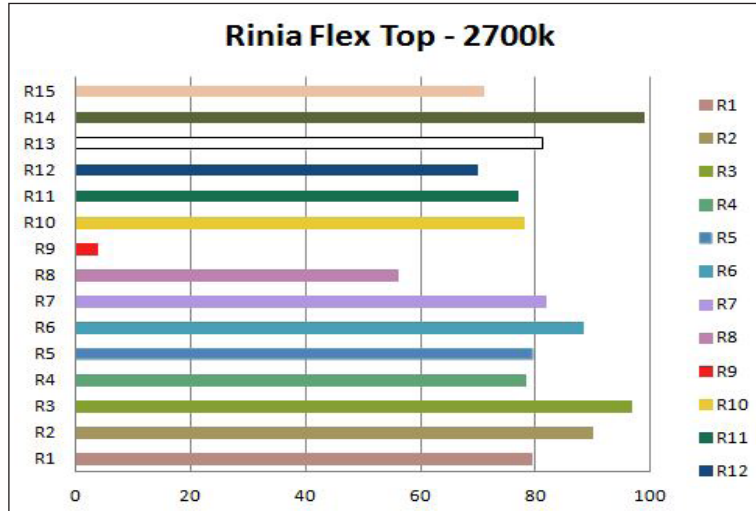

R1	79.2
R2	89.8
R3	96.6
R4	78.1
R5	79.3
R6	88
R7	81.5
R8	56
R9	3.5
R10	78
R11	76.7
R12	69.7
R13	81.2
R14	98.6
R15	70.9

Power Supplies & Control Interfaces

Power Supplies	Wattage	Voltage	Length	Height	Width
PS2024	20w	24vDC	118mm	35mm	26mm
PS6024	60w	24vDC	163mm	42.5mm	32mm
PS10024	100w	24vDC	190mm	52mm	37mm
PS15024	150w	24vDC	228mm	68mm	39mm

Dimming Interface	Control	Wattage	Length	Height	Width
PS10024PD	Mains Dimmable	100w	230mm	70mm	46mm
DINT	1-10v Dimmable	120w	172mm	42mm	20mm

Please use the recommended power supplies and dimming interfaces to ensure a smooth dimming curve.

Indicative 1-10v Wiring Diagram

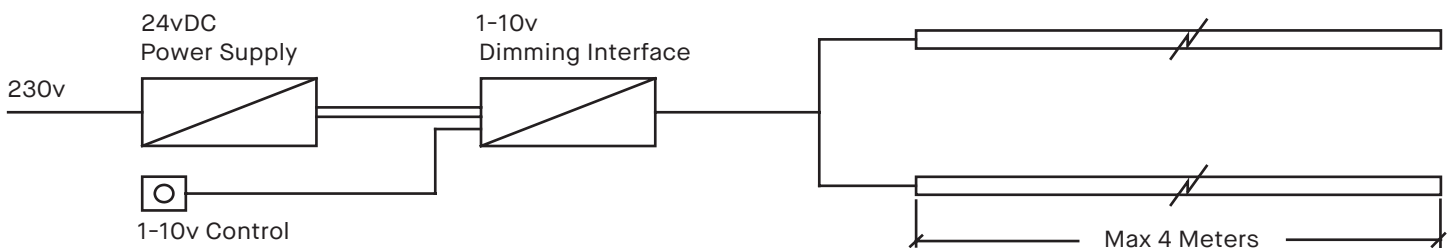

REQUIRED

OPTIONAL

RINIA LED TAPE:



Power Supply: W

Control: 1-10v / MD

PLEASE NOTE:

Power supplies & dimmable interfaces must be placed in accessible, safe and well ventilated locations. If the LED tape is to be placed over 1 Meter away from the power supply please ensure voltage drop does not exceed 3%. Electrician to ensure correct cabling is specified. Please contact lightbout.iQ for more information.

12w/m Mini Dynamic White

RINIA
TAPES

Linear LED Tape

Wattage:	12w/m		
Colour Temperature Range:	2100K - 3000K		
Colour Temperature:	2100K	2500K	3000K
LED Lumen p/m:	485lm/m	963lm/m	599lm/m
Efficacy:	66.65lm/w	74.05lm/w	83lm/w
Colour Rendering Index:	95	95	96
TM-30-15	RF; 92 RG: 102		
Voltage:	24vDC		
IP Rating:	IP20		
Lifetime:	50,000 Hours		
Operating Temperature:	-20°C tp 40°C		
	5mm (+0.25)		
Width:	5 Meters		
Maximum Reel Length:	71.4mm (+0.25)		
Cut Increments: Wiring:	Parallel		
Dimming:	0-10v / Dali / DMX		

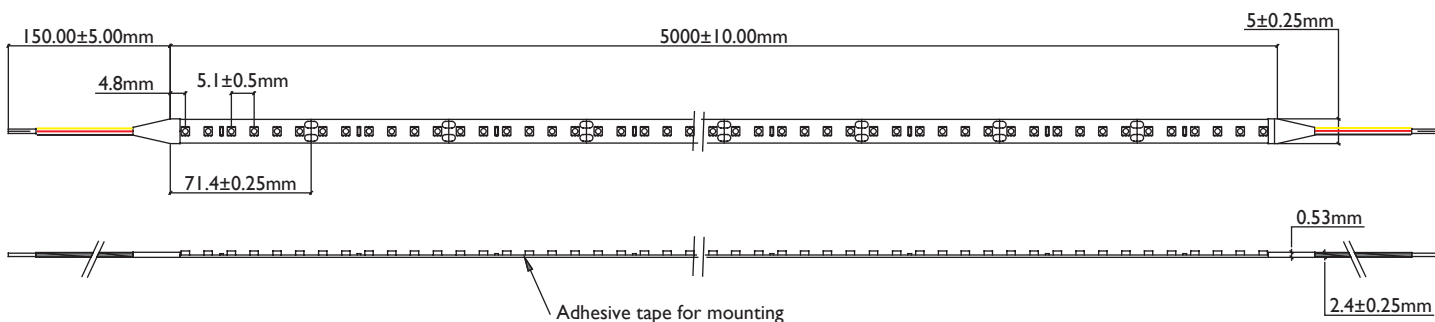

	Wattage	CCT	IP Rating	Length	Profile
RINIA LED TAPE:	12W/M	DYNAMIC	IP20	mm	Yes/No

Rinia LED tapes provide an extensive range suitable for residential and commercial applications. Binned to two to three Macadam steps, the Rinia tape provides an industry leading quality of light. Supplied in reels to be cut and soldered on site or made to order within custom profiles with end caps and pre-wired tails.

lightbout.iQ

www.lightboutiq.com

12w/m Mini Dynamic White

RINIA

TAPES

Linear LED Tape

CIE Chromaticity Diagrams:

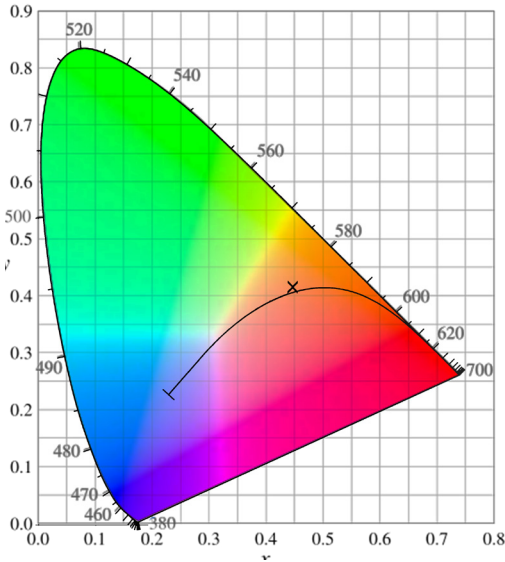

Colour Rendering Index:

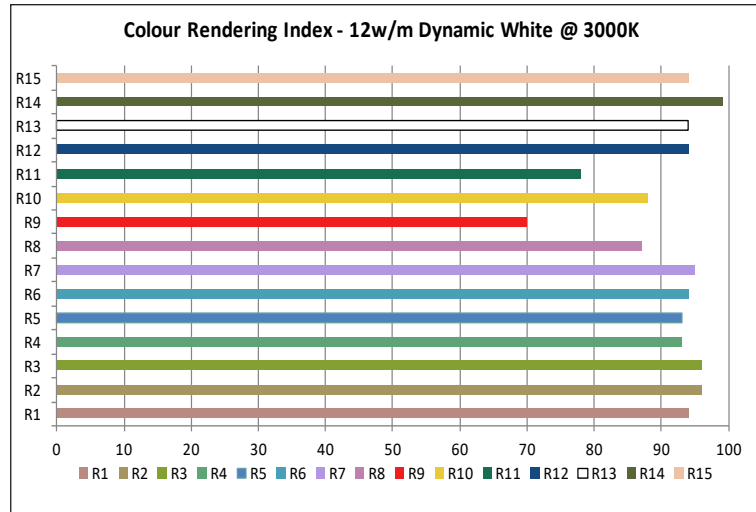

R1	94
R2	96
R3	96
R4	93
R5	93
R6	94
R7	95
R8	87
R9	70
R10	88
R11	78
R12	94
R13	94
R14	99
R15	94

Data Source: 12w/m Dynamic White Rinia LED Tape
Environment: 2.9lux 4372K

Power Supplies & Control Interfaces

Power Supplies	Wattage	Voltage	Length	Height	Width
PS6024	60w	24vDC	163mm	42.5mm	32mm
PS10024	100w	24vDC	190mm	52mm	37mm
PS15024	150w	24vDC	228mm	68mm	39mm

Dimming Interface	Control	Wattage	Length	Height	Width
ELDDIM	0-10v Dimmable	192W	153mm	23mm	50mm

Other dimming interfaces available (DALI/DMX)

Indicative 0-10v Wiring Diagram for Dynamic White Tape

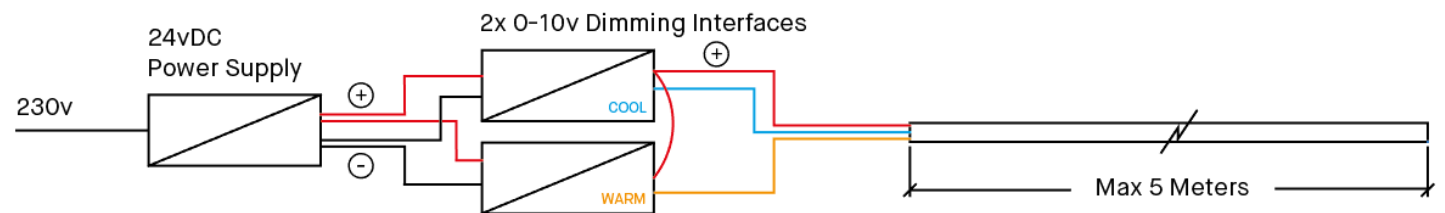

RINIA LED TAPE:	REQUIRED	OPTIONAL	Power Supply: W
	LED Tape + Heat-sink + 24vDC Power Supply + 2 x Dimming Interface	Profile	Control: 0-10v/DALI/DMX

PLEASE NOTE:

Power supplies & dimmable interfaces must be placed in accessible, safe and well ventilated locations. If the LED tape is to be placed over 1 Meter away from the power supply please ensure voltage drop does not exceed 3%. Electrician to ensure correct cabling is specified. Please contact lightbout.iQ for more information.

lightbout.iQ

www.lightboutiq.com

12w/m Side Flex

Linear LED Tape

Wattage:	12w/m	Wiring:	Parallel
LED Lumen p/m:	320lm/m	Dimming:	1-10v, Mains or DALI*
Efficacy:	26.6lm/w		
Colour Temperature:	2400K / 2700K		
Colour Rendering Index:	>80	Accessories:	End Caps
Voltage:	24vDC		Front Connector
IP Rating:	IP67		Mount Clip
			50mm Channel
Lifetime:	50,000 Hours		
Operating Temperature:	-20°C to 40°C		
Width:	11.5mm (±0.2)		
Height:	21mm (±0.2)		
Maximum Reel Length:	10 Meters		
Cut Increments:	55mm		

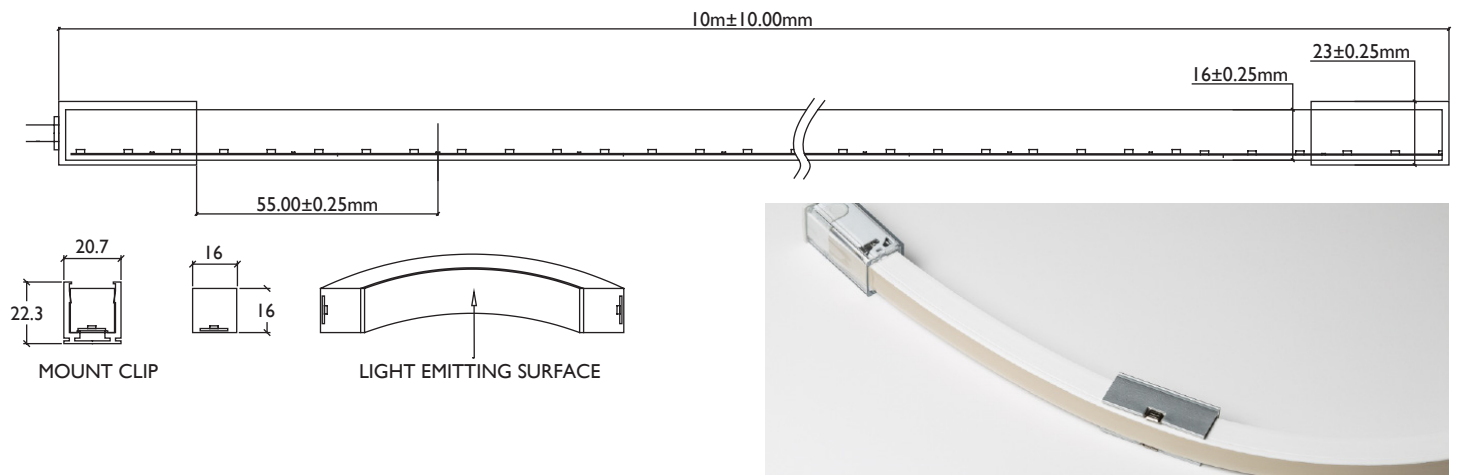

	Wattage	CCT	IP Rating	Length	Profile
RINIA LED TAPE:			IP67	mm	Yes/No

Rinia LED tapes provide an extensive range suitable for residential and commercial applications. Binned to two to three Macadam steps, the Rinia tape provides an industry leading quality of light. Supplied in reels to be cut and soldered on site or made to order within custom profiles with end caps and pre-wired tails.

12w/m Side Flex

Linear LED Tape

CIE Chromaticity Diagrams:

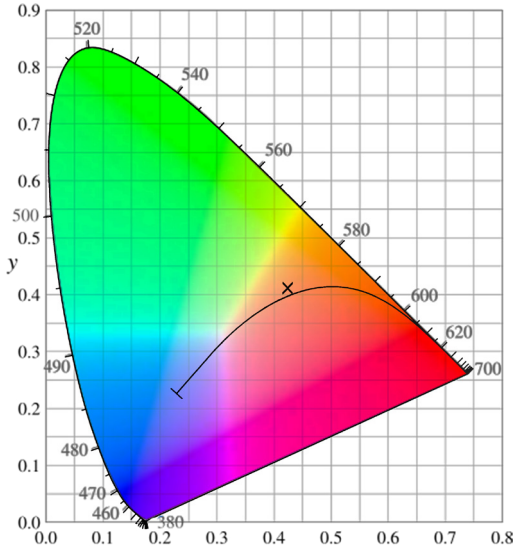

Colour Rendering Index:

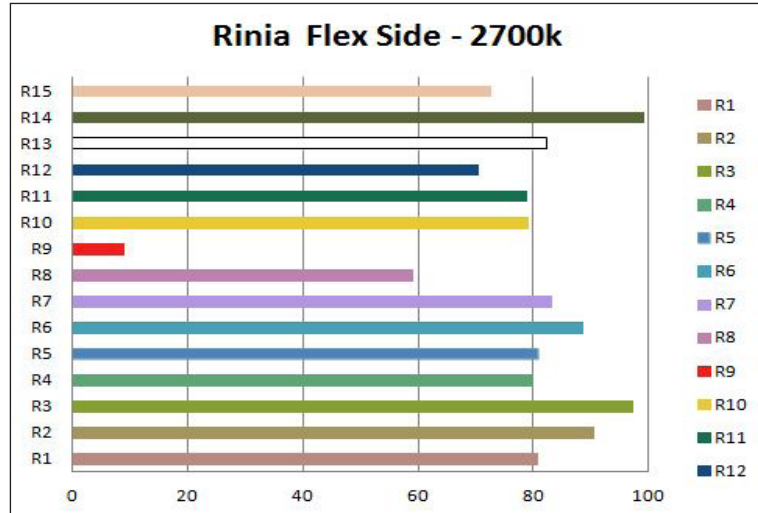

R1	80.4
R2	90.2
R3	97
R4	79.8
R5	80.6
R6	88.5
R7	83
R8	59
R9	8.7
R10	78.8
R11	78.8
R12	70.2
R13	82.3
R14	98.9
R15	72.5

Data Source: Rinia LED Side Flex

Environment: 2.9lux 4372K

Power Supplies & Control Interfaces

Power Supplies	Wattage	Voltage	Length	Height	Width
PS2024	20w	24vDC	118 _{mm}	35 _{mm}	26 _{mm}
PS6024	60w	24vDC	163 _{mm}	42.5 _{mm}	32 _{mm}
PS10024	100w	24vDC	190 _{mm}	52 _{mm}	37 _{mm}
PS15024	150w	24vDC	228 _{mm}	68 _{mm}	39 _{mm}

Dimming Interface	Control	Wattage	Length	Height	Width
PS10024PD	Mains Dimmable	100w	230 _{mm}	70 _{mm}	46 _{mm}
DINT	1-10v Dimmable	120w	172 _{mm}	42 _{mm}	20 _{mm}

Please use the recommended power supplies and dimming interfaces to ensure a smooth dimming curve.

Indicative 1-10v Wiring Diagram

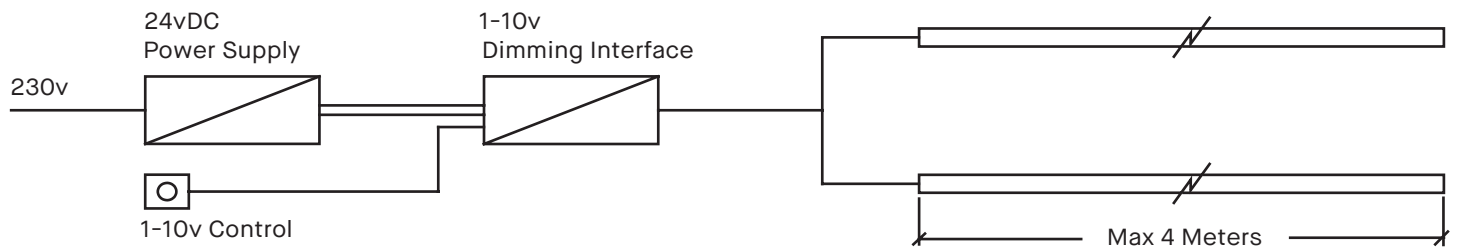

REQUIRED	OPTIONAL	Power Supply: W
+ +	+	<input type="text"/>
LED Tape Heat-sink Power Supply	Profile Dimming Interface	Control: 1-10v / MD

PLEASE NOTE:

Power supplies & dimmable interfaces must be placed in accessible, safe and well ventilated locations. If the LED tape is to be placed over 1 Meter away from the power supply please ensure voltage drop does not exceed 3%. Electrician to ensure correct cabling is specified. Please contact lightbout.iQ for more information.

15w/m Mini Tape

TAPES

Linear LED Tape

Wattage:	15w/m		
Colour Temperature:	2400K	2700K	3000K
LED Lumen p/m:	928.3lm/m	1022.7lm/m	1023lm/m
Efficacy:	68lm/w	74.62lm/w	74.64lm/w
Colour Rendering Index:	93	94	94
TM-30-15	RF: 91 RG: 101		
Voltage:	24vDC		
IP Rating:	IP20		
Lifetime:	50,000 Hours		
Operating Temperature:	-20°C to 40°C		

Width:	5mm (+0.25)
Maximum Reel Length:	5 Meters
Cut Increments:	33mm (+0.25)
Wiring:	Parallel
Dimming:	1-10v / Mains / DALI

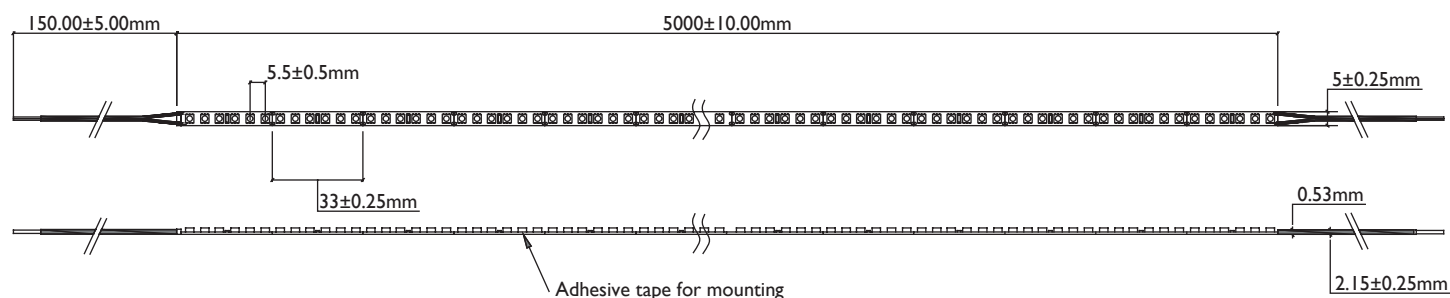

	Wattage	CCT	IP Rating	Length	Profile
RINIA LED TAPE:	15 w/m	K	IP20	mm	Yes/No

Rinia LED tapes provide an extensive range suitable for residential and commercial applications. Binned to two to three Macadam steps, the Rinia tape provides an industry leading quality of light. Supplied in reels to be cut and soldered on site or made to order within custom profiles with end caps and pre-wired tails.

lightbout.iQ

www.lightboutiq.com

15w/m Mini Tape

Linear LED Tape

CIE Chromaticity Diagrams:

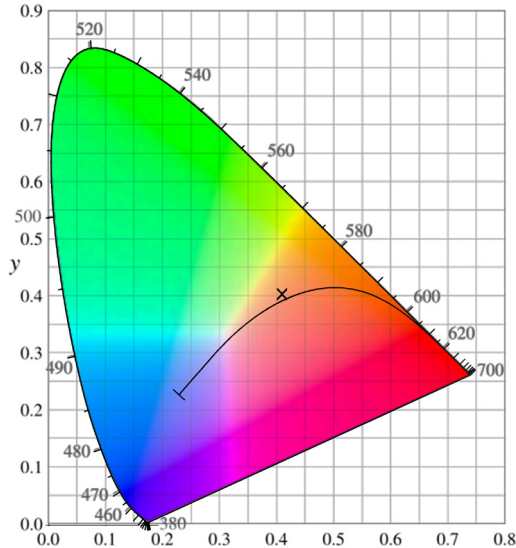

Colour Rendering Index:

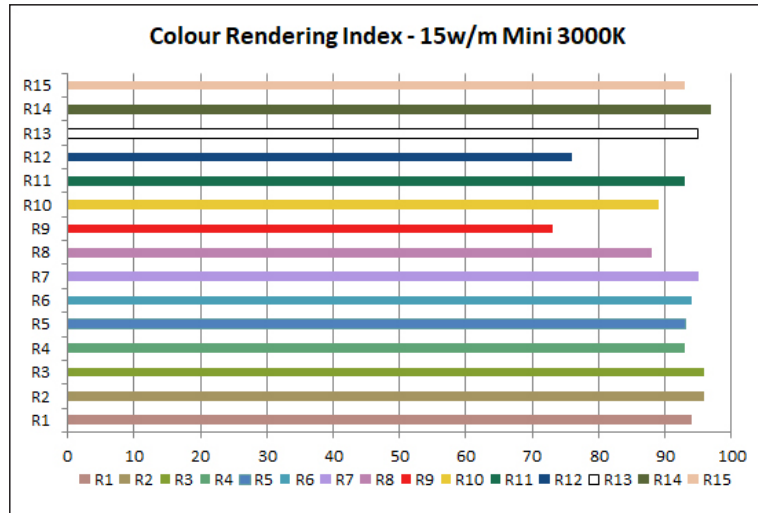

R1	94
R2	96
R3	96
R4	93
R5	93
R6	94
R7	95
R8	88
R9	73
R10	89
R11	93
R12	76
R13	95
R14	97
R15	93

Data Source: 15w/m Mini 3000k Rinia LED Tape

Environment: 1.2lux 3752K

Power Supplies & Control Interfaces

Power Supplies	Wattage	Voltage	Length	Height	Width
PS2024	20w	24vDC	118 _{mm}	35 _{mm}	26 _{mm}
PS6024	60w	24vDC	163 _{mm}	42.5 _{mm}	32 _{mm}
PS10024	100w	24vDC	190 _{mm}	52 _{mm}	37 _{mm}
PS15024	150w	24vDC	228 _{mm}	68 _{mm}	39 _{mm}

Dimming Interface	Control	Wattage	Length	Height	Width
PS10024PD	Mains Dimmable	100w	230 _{mm}	70 _{mm}	46 _{mm}
DINT	1-10v Dimmable	120w	172 _{mm}	42 _{mm}	20 _{mm}

Please use the recommended power supplies and dimming interfaces to ensure a smooth dimming curve.

Indicative 1-10v Wiring Diagram

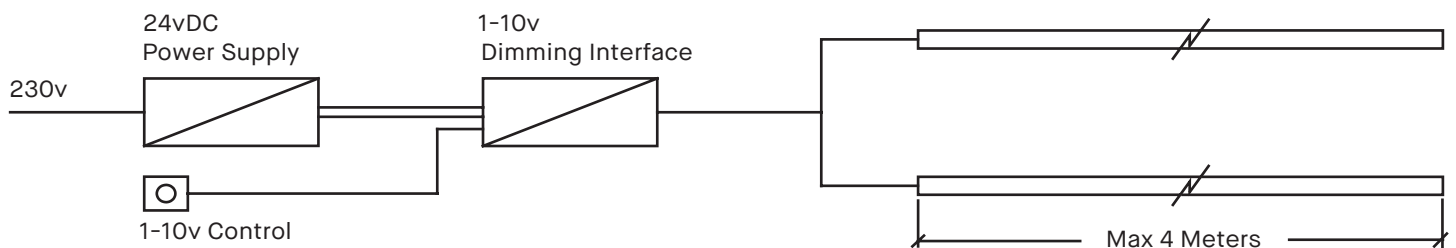

REQUIRED	OPTIONAL	Power Supply: W
+ +	+	
LED Tape	Profile	Control: 1-10v / MD

PLEASE NOTE:

Power supplies & dimmable interfaces must be placed in accessible, safe and well ventilated locations. If the LED tape is to be placed over 1 Meter away from the power supply please ensure voltage drop does not exceed 3%. Electrician to ensure correct cabling is specified. Please contact lightbout.iQ for more information.

15w/m IP65

Linear LED Tape

Wattage: 15w/m
 LED Lumen p/m: 690lm/m
 Efficacy: 46lm/w
Colour Temperature: 2700K
 Colour Rendering Index: +80CRI
 Voltage: 24vDC
 IP Rating: IP65

Lifetime: 50,000 Hours
 Operating Temperature: -20°C to 40°C

Width: 12mm (+0.25)
 Maximum Reel Length: 5 Meters
 Cut Increments: 100mm (+0.25)
 Wiring: Parallel
 Dimming: 1-10v / Mains / DALI*

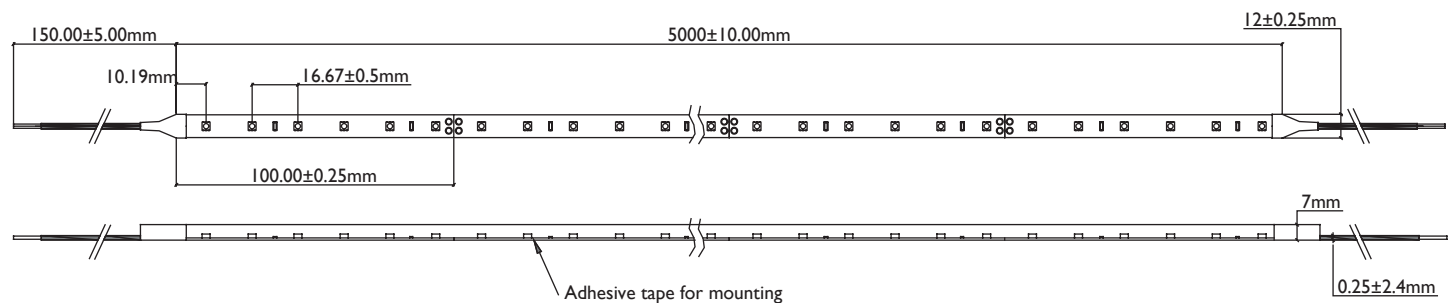

	Wattage	CCT	IP Rating	Length	Profile
RINIA LED TAPE:	15 w/m	K	IP65	mm	Yes/No

Rinia LED tapes provide an extensive range suitable for residential and commercial applications. Binned to two to three Macadam steps, the Rinia tape provides an industry leading quality of light. Supplied in reels to be cut and soldered on site or made to order within custom profiles with end caps and pre-wired tails.

15w/m IP65

Linear LED Tape

CIE Chromaticity Diagrams:

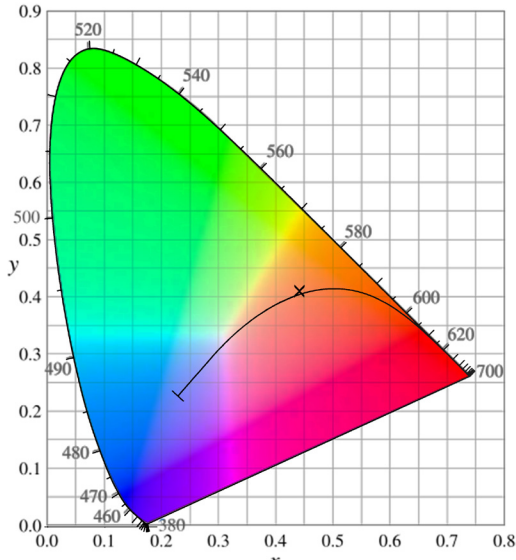

Data Source: 24w/m IP54 Rinia LED Tape

Environment: 2.9lux 4372K

Colour Rendering Index:

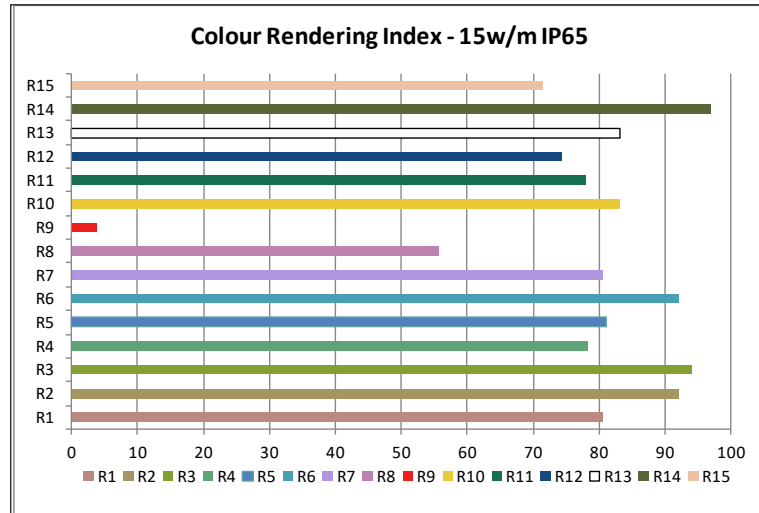

R1	81
R2	92
R3	94
R4	78
R5	81
R6	92
R7	81
R8	56
R9	4
R10	83
R11	78
R12	74
R13	83
R14	97
R15	71

Power Supplies & Control Interfaces

Power Supplies	Wattage	Voltage	Length	Height	Width
PS2024	20w	24vDC	118mm	35mm	26mm
PS6024	60w	24vDC	163mm	42.5mm	32mm
PS10024	100w	24vDC	190mm	52mm	37mm
PS15024	150w	24vDC	228mm	68mm	39mm

Dimming Interface	Control	Wattage	Length	Height	Width
PS10024PD	Mains Dimmable	100w	230mm	70mm	46mm
DINT	1-10v Dimmable	120w	172mm	42mm	20mm

Please use the recommended power supplies and dimming interfaces to ensure a smooth dimming curve.

Indicative 1-10v Wiring Diagram

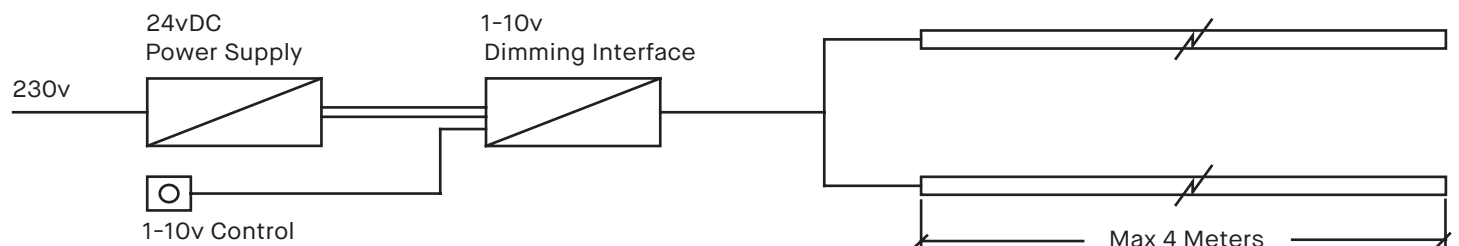

RINIA LED TAPE:	REQUIRED + +	OPTIONAL +	Power Supply: W
			Control: 1-10v / MD

PLEASE NOTE:

Power supplies & dimmable interfaces must be placed in accessible, safe and well ventilated locations. If the LED tape is to be placed over 1 Meter away from the power supply please ensure voltage drop does not exceed 3%. Electrician to ensure correct cabling is specified. Please contact lightbout.iQ for more information.

20w/m

Linear LED Tape

Wattage:	20w/m			
LED Lumen p/m:	900lm/m	960lm/m	1060lm/m	1090lm/m
Efficacy:	45lm/w	48lm/w	53lm/w	54.5lm/w
Colour Temperature:	2000K	2400K	2700K	3000K
Colour Rendering Index:	+93CRI			
Voltage:	24vDC			
IP Rating:	IP20			

Lifetime: 50,000 Hours
 Operating Temperature: -20°C to 40°C

Width: 10mm (+0.25)
 Maximum Reel Length: 5 Meters
 Cut Increments: 33mm (+0.25)
 Wiring: Parallel
 Dimming: 1-10v / Mains / DALI*

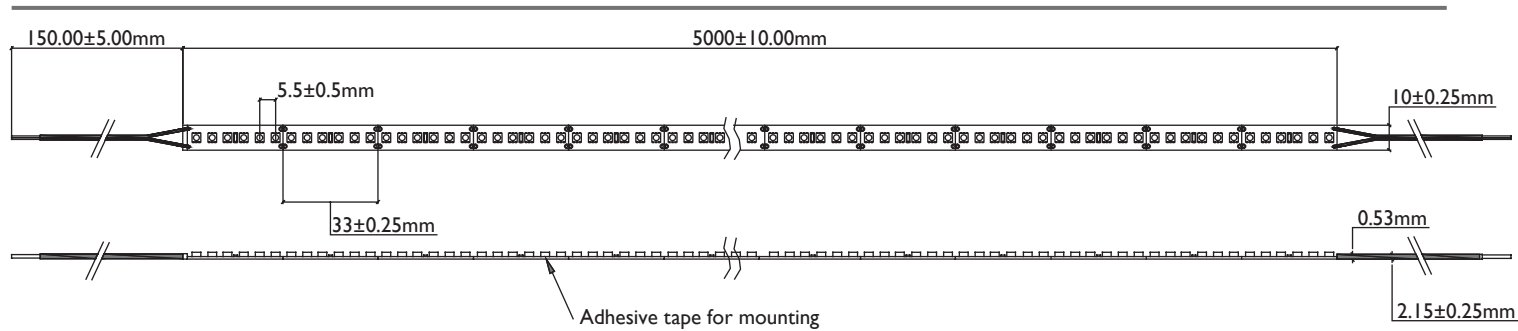

+90 CRI

	Wattage	CCT	IP Rating	Length	Profile
RINIA LED TAPE:	20 w/m	K	IP20	mm	Yes/No

Rinia LED tapes provide an extensive range suitable for residential and commercial applications. Binned to two to three Macadam steps, the Rinia tape provides an industry leading quality of light. Supplied in reels to be cut and soldered on site or made to order within custom profiles with end caps and pre-wired tails.

CIE Chromaticity Diagrams:

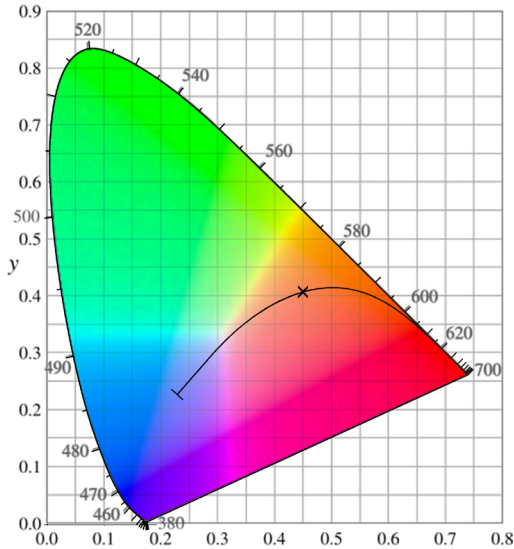

Colour Rendering Index:

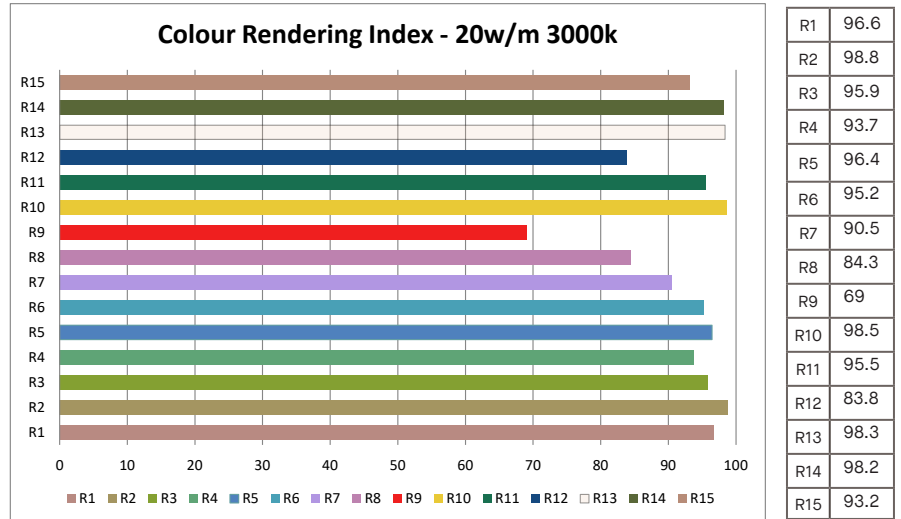

Data Source: 20w/m 3000k Rinia LED Tape

Environment: 2.9lux 4372K

Power Supplies & Control Interfaces

Power Supplies	Wattage	Voltage	Length	Height	Width
PS2024	20w	24vDC	118 _{mm}	35 _{mm}	26 _{mm}
PS6024	60w	24vDC	163 _{mm}	42.5 _{mm}	32 _{mm}
PS10024	100w	24vDC	190 _{mm}	52 _{mm}	37 _{mm}
PS15024	150w	24vDC	228 _{mm}	68 _{mm}	39 _{mm}

Dimming Interface	Control	Wattage	Length	Height	Width
PS10024PD	Mains Dimmable	100w	230 _{mm}	70 _{mm}	46 _{mm}
DINT	1-10v Dimmable	120w	172 _{mm}	42 _{mm}	20 _{mm}

Please use the recommended power supplies and dimming interfaces to ensure a smooth dimming curve.

Indicative 1-10v Wiring Diagram

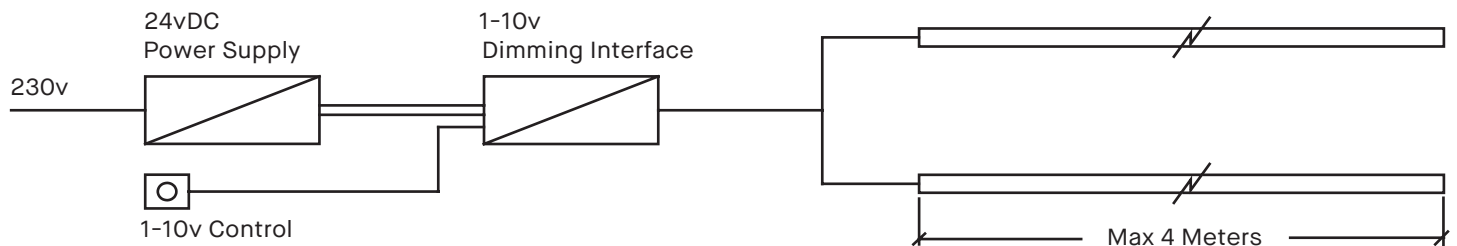

REQUIRED	OPTIONAL	
RINIA LED TAPE: 		Power Supply: W Control: 1-10v / MD

PLEASE NOTE:

Power supplies & dimmable interfaces must be placed in accessible, safe and well ventilated locations. If the LED tape is to be placed over 1 Meter away from the power supply please ensure voltage drop does not exceed 3%. Electrician to ensure correct cabling is specified. Please contact lightbout.iQ for more information.

22w/m Dynamic White

Linear LED Tape

Wattage:	22w/m		
Colour Temperature Range:	2100K - 3000K		
Colour Temperature:	2100K	2500K	3000K
LED Lumen p/m:	728lm/m	1474lm/m	892lm/m
Efficacy:	34lm/w	67lm/w	40.5lm/w
Colour Rendering Index:	96	97	97
Voltage:	24vDC		
IP Rating:	IP20		

Lifetime: 50,000 Hours
 Operating Temperature: -20°C tp 40°C

Width: 10mm (+0.25)
 Maximum Reel Length: 5 Meters
 Cut Increments: 50mm (+0.25)
 Dimming Protocol: 0-10v / Dali / DMX

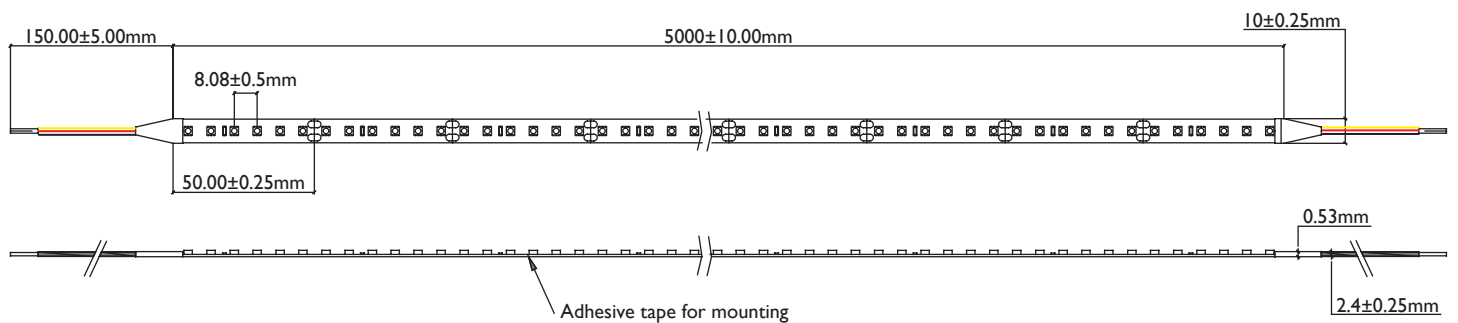

	Wattage	CCT	IP Rating	Length	Profile
RINIA LED TAPE:	22W/M	DYNAMIC	IP20	mm	Yes/No

Rinia LED tapes provide an extensive range suitable for residential and commercial applications. Binned to two to three Macadam steps, the Rinia tape provides an industry leading quality of light. Supplied in reels to be cut and soldered on site or made to order within custom profiles with end caps and pre-wired tails.

22w/m Dynamic White

Linear LED Tape

CIE Chromaticity Diagrams:

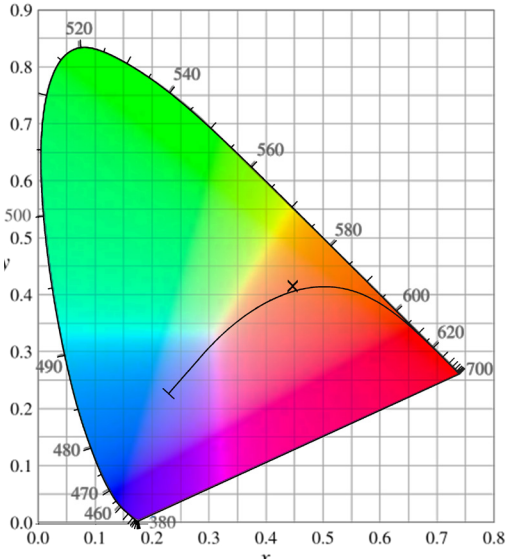

Data Source: 22w/m Dynamic White Rinia LED Tape
Environment: 2.9lux 4372K

Colour Rendering Index:

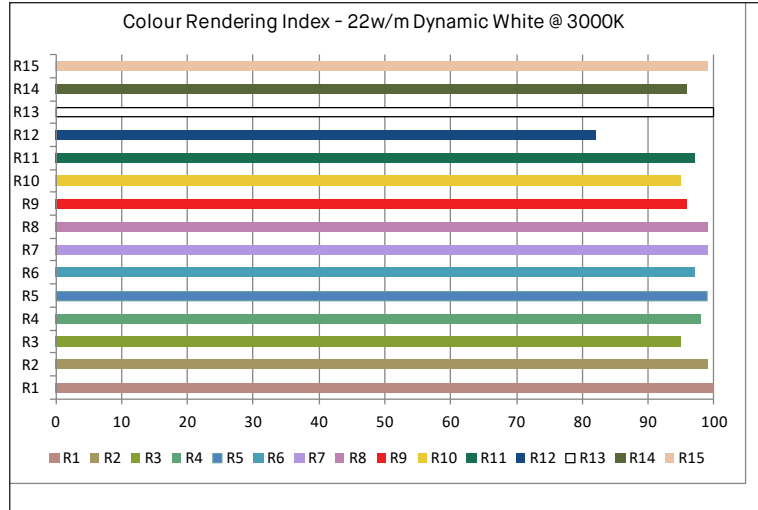

R1	100
R2	99
R3	95
R4	98
R5	99
R6	97
R7	99
R8	99
R9	96
R10	95
R11	97
R12	82
R13	100
R14	96
R15	99

Power Supplies & Control Interfaces

Power Supplies	Wattage	Voltage	Length	Height	Width
PS6024	60w	24vDC	163mm	42.5mm	32mm
PS10024	100w	24vDC	190mm	52mm	37mm
PS15024	150w	24vDC	228mm	68mm	39mm

Dimming Interface	Control	Wattage	Length	Height	Width
ELDDIM	0-10v Dimmable	192W	153mm	23mm	50mm

Other dimming interfaces available (DALI/DMX)

Indicative 0-10v Wiring Diagram for Dynamic White Tape

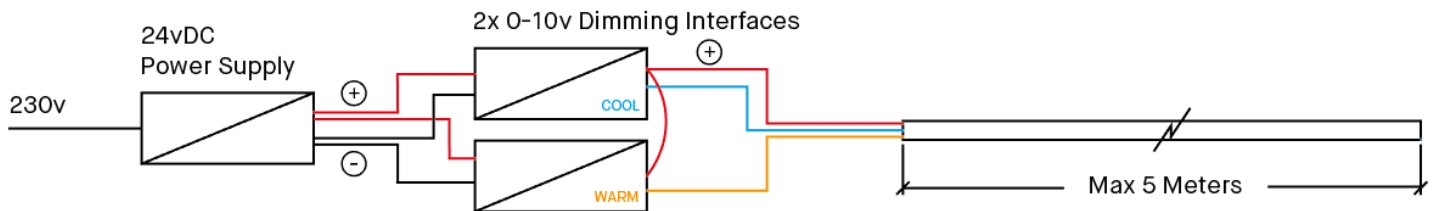

RINIA LED TAPE:

REQUIRED

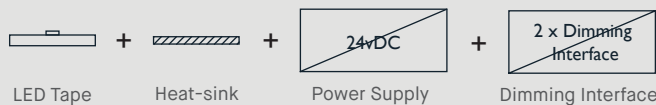

OPTIONAL



Power Supply: W

Control: 0-10v/DALI/DMX

PLEASE NOTE:

Power supplies & dimmable interfaces must be placed in accessible, safe and well ventilated locations. If the LED tape is to be placed over 1 Meter away from the power supply please ensure voltage drop does not exceed 3%. Electrician to ensure correct cabling is specified. Please contact lightbout.iQ for more information.

24w/m Pro

Linear LED Tape

Wattage:	24w/m	
LED Lumen p/m:	>1557lm/m	>1752lm/m
Efficacy:	64.5lm/w	72lm/w
Colour Temperature:	2700K	3000K
Colour Rendering Index:	97+	
Voltage:	24vDC	
IP Rating:	IP20	

Lifetime:	50,000 Hours
Operating Temperature:	-20°C to 40°C

Width:	10mm (+0.25)
Maximum Reel Length:	5 Meters
Cut Increments:	25mm (+0.25)
Wiring:	Parallel
Dimming:	1-10v / Mains / DALI*

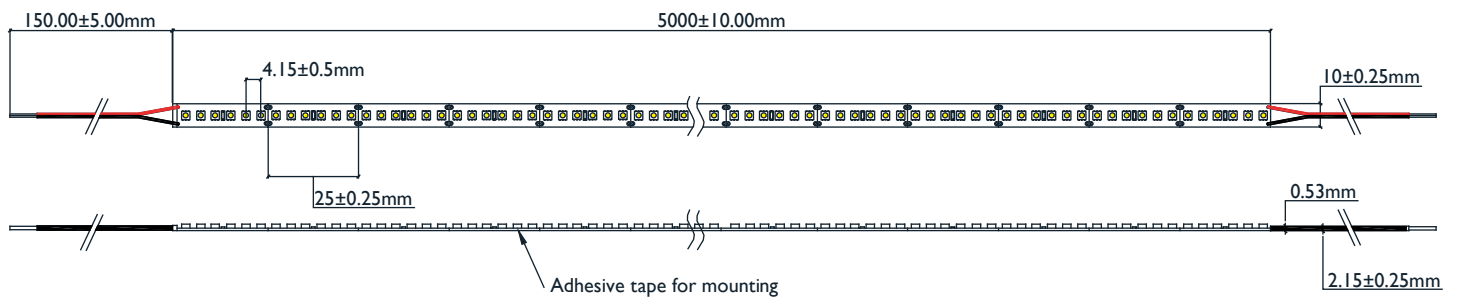

	Wattage	CCT	IP Rating	Length	Profile
RINIA LED TAPE:		K	IP20	mm	Yes/No

Rinia LED tapes provide an extensive range suitable for residential and commercial applications. Binned to two to three Macadam steps, the Rinia tape provides an industry leading quality of light. Supplied in reels to be cut and soldered on site or made to order within custom profiles with end caps and pre-wired tails.

24w/m Pro

Linear LED Tape

CIE Chromaticity Diagrams:

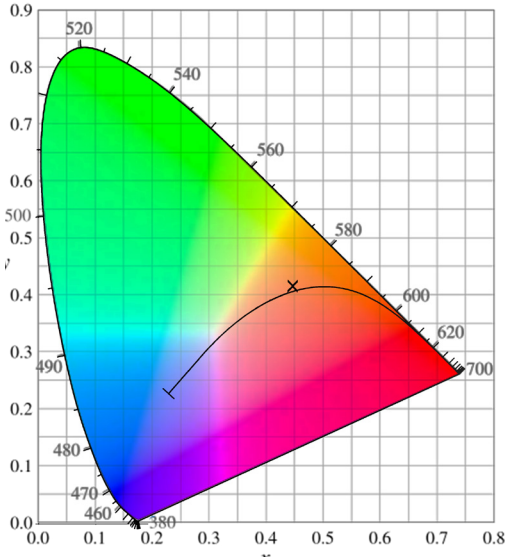

Data Source: 24w/m 3000k Rinia LED Tape
Environment: 2.9lux 4372K

Colour Rendering Index:

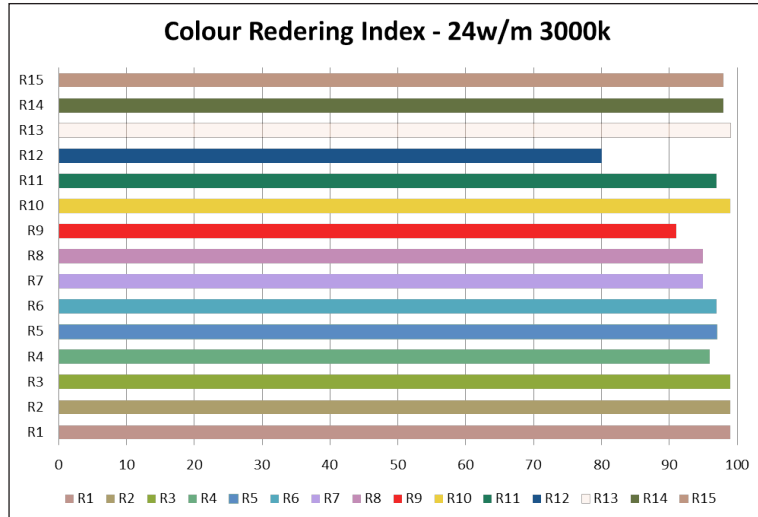

R1	99
R2	99
R3	99
R4	96
R5	97
R6	97
R7	95
R8	95
R9	91
R10	99
R11	97
R12	80
R13	99
R14	98
R15	98

Power Supplies & Control Interfaces

Power Supplies	Wattage	Voltage	Length	Height	Width
PS2024	20w	24vDC	118 _{mm}	35 _{mm}	26 _{mm}
PS6024	60w	24vDC	163 _{mm}	42.5 _{mm}	32 _{mm}
PS10024	100w	24vDC	190 _{mm}	52 _{mm}	37 _{mm}
PS15024	150w	24vDC	228 _{mm}	68 _{mm}	39 _{mm}

Dimming Interface	Control	Wattage	Length	Height	Width
PS10024PD	Mains Dimmable	100w	230 _{mm}	70 _{mm}	46 _{mm}
DINT	1-10v Dimmable	120w	172 _{mm}	42 _{mm}	20 _{mm}

Please use the recommended power supplies and dimming interfaces to ensure a smooth dimming curve.

Indicative 1-10v Wiring Diagram

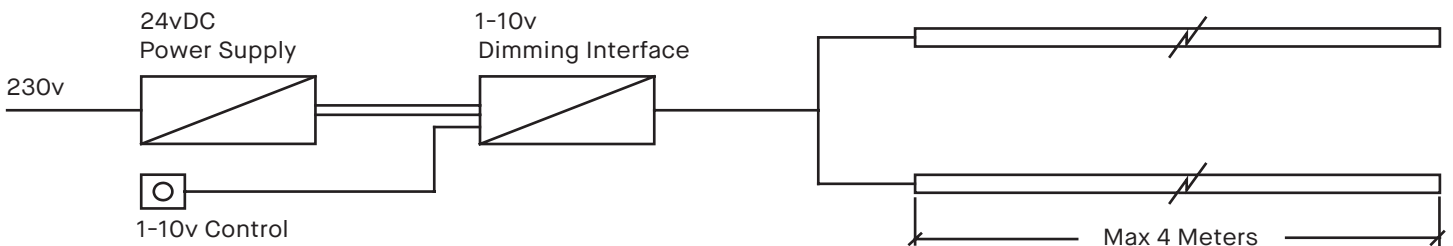

REQUIRED	OPTIONAL	Power Supply: W
+ +	+	
LED Tape	Profile	Control: 1-10v / MD

PLEASE NOTE:

Power supplies & dimmable interfaces must be placed in accessible, safe and well ventilated locations. If the LED tape is to be placed over 1 Meter away from the power supply please ensure voltage drop does not exceed 3%. Electrician to ensure correct cabling is specified. Please contact lightbout.iQ for more information.

38w/m

Linear LED Tape

Wattage:	38w/m		
LED Lumen p/m:	4300lm/m	4346lm/m	4373lm/m
Efficacy:	113.15lm/w	114lm/w	115lm/w
Colour Temperature:	2400K	2700K	3000K
Colour Rendering Index:	90CRI		
Voltage:	24vDC		
IP Rating:	IP20		

Lifetime:	50,000 Hours
Operating Temperature:	-20°C to 40°C

Width:	10mm (+0.25)
Maximum Reel Length:	5 Meters
Cut Increments:	35.7mm (+0.25)
Wiring:	Parallel
Dimming:	1-10v / Mains / DALI*

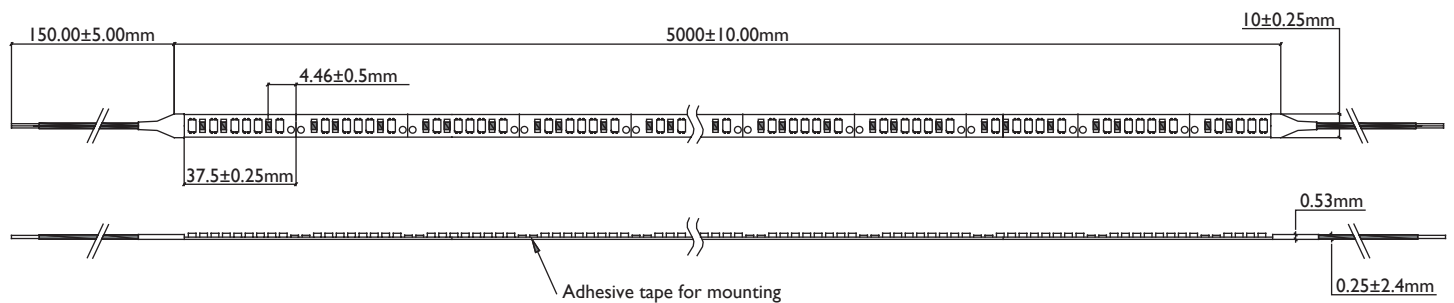

+90 CRI

SINGLE BINNING

Please Note: 38w/m Rinia Tape is only suitable for use in the Rinia Box, Rinia Dome & Rinia Square Profile with 10° Grazing Optic.

	Wattage	CCT	IP Rating	Length	Profile
RINIA LED TAPE:		K	IP20	mm	Yes/No

Rinia LED tapes provide an extensive range suitable for residential and commercial applications. Binned to two to three Macadam steps, the Rinia tape provides an industry leading quality of light. Supplied in reels to be cut and soldered on site or made to order within custom profiles with end caps and pre-wired tails.

38w/m

Linear LED Tape

CIE Chromaticity Diagrams:

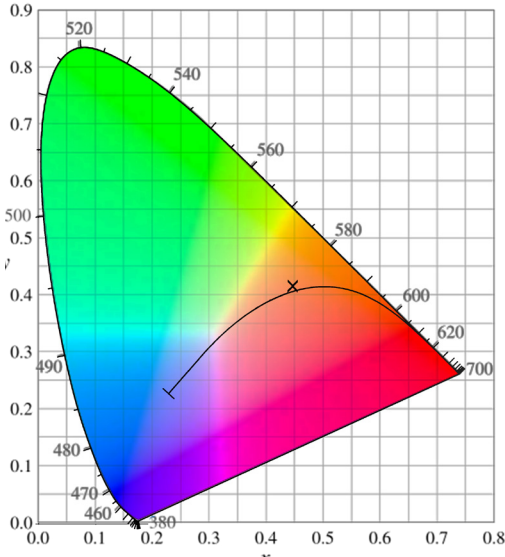

Data Source: 34w/m 3000k Rinia LED Tape
Environment: 2lux 4350K

Colour Rendering Index:

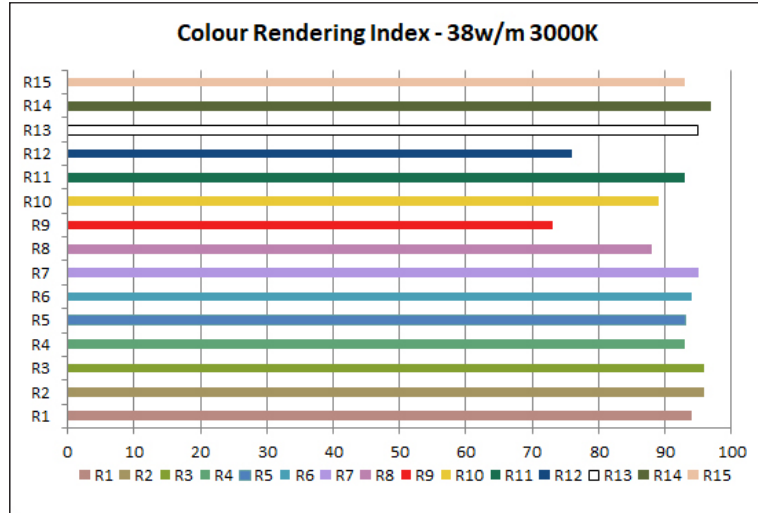

R1	93
R2	97
R3	98
R4	93
R5	93
R6	96
R7	93
R8	84
R9	65
R10	91
R11	93
R12	80
R13	94
R14	98
R15	90

Power Supplies & Control Interfaces

Power Supplies	Wattage	Voltage	Length	Height	Width
PS6024	60w	24vDC	163mm	42.5mm	32mm
PS10024	100w	24vDC	190mm	52mm	37mm
PS15024	150w	24vDC	228mm	68mm	39mm

Dimming Interface	Control	Wattage	Length	Height	Width
PS10024PD	Mains Dimmable	100w	230mm	70mm	46mm
DINT	1-10v Dimmable	120w	172mm	42mm	20mm

Please use the recommended power supplies and dimming interfaces to ensure a smooth dimming curve.

Indicative 1-10v Wiring Diagram

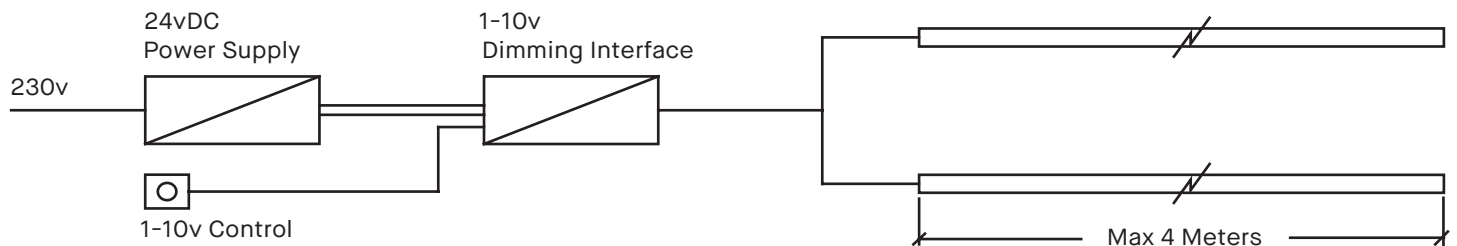

REQUIRED	OPTIONAL	Power Supply: W
+ +	+	Control: 1-10v / MD

PLEASE NOTE:

Power supplies & dimmable interfaces must be placed in accessible, safe and well ventilated locations. If the LED tape is to be placed over 1 Meter away from the power supply please ensure voltage drop does not exceed 3%. Electrician to ensure correct cabling is specified. Please contact lightbout.iQ for more information.

lightbout.iQ

0203 198 9002

enquiries@lightboutiq.com

www.lightboutiq.com